



# Installation Guide

Matrix™ Cladding

EXTERIORS

**Australia** August 2021

**Make sure your information is up to date.**



When specifying or installing James Hardie™ products, ensure that you have the current technical information and guides. If in doubt, or you need more information, visit [www.jameshardie.com.au](http://www.jameshardie.com.au) or Ask James Hardie™ on 13 11 03.



## Installation Guide



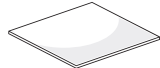







### IMPORTANT NOTES

1. Failure to install, finish or maintain this product in accordance with applicable building codes, regulations, standards and James Hardie's written application instructions may lead to personal injury, affect system performance, violate local building codes, and void James Hardie's product warranty.
2. All warranties, conditions, liabilities (direct, indirect or consequential) and obligations whether arising in contract, tort or otherwise other than those specified in James Hardie's product warranty are excluded to the fullest extent allowed by law. For James Hardie's product warranty information and disclaimers about the information in this guide, refer to [www.jameshardie.com.au](http://www.jameshardie.com.au).
3. The builder must ensure the product meets aesthetic requirements before installation. James Hardie™ will not be responsible for rectifying aesthetic surface variations following installation.
4. Make sure your information is up to date. When specifying or installing James Hardie™ products, ensure you have the current guide. If in doubt, or you need more information, visit [www.jameshardie.com.au](http://www.jameshardie.com.au) or Ask James Hardie™ on 13 11 03.

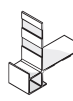



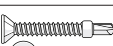

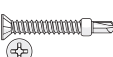

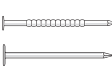

MATRIX™ SHEET AND CAVITY TRIM PRODUCT SIZE				
PRODUCT	LENGTH (mm)	WIDTH (mm)	THICKNESS (mm)	MASS (kg)
MATRIX™ PANEL 	1190	1190	8	18
	2390	590	8	18
	2990	1190	8	45
CAVITY TRIM 	2450	70	19	3.4

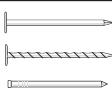
All dimensions and masses provided are approximate only and subject to manufacturing tolerances. Masses are based on equilibrium moisture content of product.

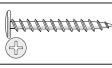
### ACCESSORIES / TOOLS SUPPLIED BY JAMES HARDIE

ACCESSORIES	DESCRIPTION	ACCESSORIES	DESCRIPTION
	<b>James Hardie™ Base Coat. 4kg tub &amp; 15kg bag</b> A water-resistant base coat compound used to flush over epoxy filled countersunk fasteners. 4kg tub 4 per box Part No. 305535. 15kg bag 1 each Part No. 304491		<b>James Hardie™ Backing Strip. 1190mm, 2390mm, 2990mm long</b> A weather seal at horizontal panel joints for use with Matrix™ cladding. 10 per pack. 1190mm Part No. 305557. 2390mm Part No. 305558. 2990mm Part No. 305559.
	<b>James Hardie™ Joint Sealant. 300ML cartridge</b> A general purpose, paintable, exterior grade polyurethane joint sealant. 20 per box. Part No. 305534.		<b>James Hardie™ 18mm PVC Cavity Vent Strip. 3,000mm Long</b> A perforated PVC extrusion used at the bottom of walls behind Matrix™ cladding. 25 per pack. Part No. 305555
	<b>James Hardie™ Facade Washers</b> Façade washers used for exposed fastener fixing with Matrix™ cladding. 1000 per bag. Part No. 305565		<b>James Hardie™ 9mm Aluminium External Corner. 3,000mm long</b> A ready to paint aluminium extrusion, to be used with Matrix™ cladding, Axon™ cladding and EasyLap™ panel at external corner junctions to conceal the board edge. 5 per pack. Part No. 305521
	<b>12mm Double Sided Bonding Tape</b> Alternate method to fix the lower part of the JH backing strip to the back of the Matrix panel at horizontal joints. 33m long roll Part No. 305673		<b>HardieEdge™ Trim</b> An architectural slab edge solution fabricated from high-quality powder coated aluminium. Base Trim unit size: 3950mm. Also available: Base Trim 4 per pack. Part No. 305911 Base Trim Joints 12 per pack. Part No. 305912 Internal Corner 4 per pack. Part No. 305913 External Corner 4 per pack. Part No. 305914
	<b>HardieWrap™ weather barrier</b> A non-perforated, highly breathable and reflective safe-glare weather barrier designed to be used behind external cladding products to help protect the building. For alternate products, please refer to HardieWrap™ weather barrier section (p.2). Unit size 2750mm x 30,000mm. 1 each. Part No. 305664		<b>HardieDrive™ Screw 41mm Long*</b> A class 3 self-tapping wing-tipped screw for fastening to 0.5mm to 1.6mm BMT light gauge steel frames. 1000 per box. Part No. 305984
	<b>HardieBlade™ Saw Blade. 185mm diameter</b> A 185mm diameter poly-diamond blade for fast and clean cutting of James Hardie™ fibre cement. 1 each. Part No. 300660		<b>HardieDrive™ Collated Screw 41mm long*</b> A class 3 self-tapping wing-tipped screw for fastening to 0.5mm to 1.6mm BMT light gauge steel frames. Suitable for use in most auto feed screw guns. 1000 per box. Part No. 305982

**COMPONENTS NOT SUPPLIED BY JAMES HARDIE** James Hardie recommends the following products for use in conjunction with its Matrix™ cladding. James Hardie does not supply these products and does not provide a warranty for their use. Please contact the component manufacturer for information on their warranties and further information on their products.

	<b>Gun Nail Trim To Frame</b> 2.8mm x 65mm long ring shank nail or 75 x 2.8mm D or round head galvanised smooth shank nail used to fix cavity trim to timber stud. Min. Class 3		<b>Epoxy flush sealing (2 part)</b> Countersunk head screws are flush sealed using megapoxy P1.
	<b>Nails To Fix Panel To cavity trim</b> 2.8 x 30mm galvanised nail, 2.6 x 32mm galvanised or stainless steel twist shank nail. Nail head must be a minimum round head diameter of 5.3mm, 25mm DA stainless steel Brad Nail for fixing Matrix panels to cavity trim.		<b>6mm masonry drill and countersunk head drill</b> Drill bit provides a 6.2mm to 6.3mm diameter hole. Used to pre-drill clearance holes for screw fasteners. The countersunk head drill is used to countersink fasteners.
	<b>Exposed head fasteners</b> No. 8-15 x 25mm washer, hex or pan head needle point screw. Class 3 minimum coating.		<b>Nail gun</b> Suitable for use with the C25 304 stainless steel brad nails.
	<b>Countersunk screws</b> 8-10 x 25 stainless steel countersunk chipboard screw square drive / needle point screw.		<b>M class or higher vacuum</b> Required to reduce the exposure to respirable dust and crystalline silica.
	<b>3M HIPA 300 adhesive cleaner</b> For cleaning of surfaces prior to applying double sided tape to the JH backing strip. Supplied by 3M Australia Pty Ltd. Part no. AS010418940		<b>Dust-reducing saw with M class or higher vacuum extraction</b> Dust reducing saw with a HardieBlade™ saw blade. Makita 5057KB / Hitachi C7YA
			<b>C25 stainless steel brad nails</b> C25 16 gauge 304 stainless steel brad nails used with James Hardie™ joint sealant for fixing Matrix panels to the cavity trim. Pack of 2000 includes fuel cell.

### WARNING - DO NOT BREATHE DUST AND CUT ONLY IN WELL VENTILATED AREA

James Hardie products contain sand, a source of respirable crystalline silica. **May cause cancer if dust from product is inhaled. Causes damage to lungs and respiratory system through prolonged or repeated inhalation of dust from product.**

Intact fibre cement products are not expected to result in any adverse toxic effects. The hazard associated with fibre cement arises from the respirable crystalline silica present in dust generated by activities such as cutting, rebating, drilling, routing, sawing, crushing, or otherwise abrading fibre cement, and when cleaning up, disposing of or moving dust.

When doing any of these activities in a manner that generates dust, follow James Hardie instructions and best practices to reduce or limit the release of dust, warn others in the area and consider rotating personnel across the cutting task to further limit respirable silica exposure.

If using a dust mask or respirator, use an AS/NZS1716 P1 filter and refer to Australian/ New Zealand Standard 1715:2009 Selection, Use and Maintenance of Respiratory Protective Equipment for more extensive guidance and more options for selecting respirators for workplaces. For further information, refer to our installation instructions and Safety Data Sheets available at [www.jameshardie.com.au](http://www.jameshardie.com.au). FAILURE TO ADHERE TO OUR WARNINGS, SAFETY DATA SHEETS, AND INSTALLATION INSTRUCTIONS MAY LEAD TO SERIOUS PERSONAL INJURY OR DEATH.

### JAMES HARDIE RECOMMENDED SAFE WORKING PRACTICES

#### CUTTING OUTDOORS

1. Position cutting station so wind will blow dust away from the user or others in working area.
2. Warn others in the area to avoid dust.
3. Consider rotating personnel across cutting tasks to further limit respirable silica exposures.
4. Use one of the following methods based on the required cutting rate:
  - Best • Villaboard™ knife • Hand guillotine • Fibreshear Better • Position the cutting station in a well-ventilated area. Use a dust reducing circular saw equipped with HardieBlade™ Saw Blade or comparable fibre cement blade and well maintained M-class vacuum or higher with appropriate filter for capturing fine (respirable) dust. Wear a properly-fitted, approved dust mask or respirator (minimum P1).

#### CUTTING INDOORS

- Cut only using Villaboard™ knife, hand guillotine or fibreshear (manual, electric or pneumatic).
- Position cutting station in a well-ventilated area.

#### DRILLING/OTHER MACHINING

When drilling or machining you should always wear a P1 dust mask and warn others in the immediate area.

#### IMPORTANT NOTES

1. For maximum protection (lowest respirable dust production) James Hardie recommends always using best practice cutting methods where feasible.
2. NEVER use a power saw indoors or in a poorly ventilated area.
3. ALWAYS use a dust reducing circular saw equipped with a sawblade specifically designed to minimise dust creation when cutting fibre cement - preferably a sawblade that carries the HardieBlade™ logo or one with at least equivalent performance - connected to a M class or higher vacuum.
4. NEVER dry sweep - Use wet suppression, or an M class vacuum or higher with appropriate filter.
5. NEVER use grinders.
6. ALWAYS follow tool manufacturers' safety recommendations.
7. ALWAYS wear a properly fitted, approved dust mask, P1 or higher

#### DUST MASKS AND RESPIRATORS

As a minimum, an AS/NZS1716 P1 respirator must be used when doing any activity that may create dust. For more extensive guidance and options for selecting respirators for workplaces please refer to Australian/New Zealand Standard 1715:2009 "Selection, Use and Maintenance of Respiratory Protective Equipment". P1 respirators should be used in conjunction with the above cutting practices to minimise dust exposure. For further information, refer to Safety Data Sheet (SDS) available at [www.jameshardie.com.au](http://www.jameshardie.com.au). If concern still exists about exposure levels or you do not comply with the above practices, you should always consult a qualified industrial hygienist or contact James Hardie for further information.

## STORAGE AND HANDLING

To avoid damage, all James Hardie™ building products should be stored with edges and corners of the product protected from chipping. James Hardie™ building products must be installed in a dry state and protected from weather during transport and storage. The product must be laid flat under cover on a smooth level surface clear of the ground to avoid exposure to water, moisture, etc.

## INTRODUCTION AND SCOPE

### General

Matrix™ cladding consists of cavity trim installed over HardieWrap™ weather barrier to which the pre-sealed Matrix™ panels are fixed. Expressed vertical and horizontal joints are created to produce a panelised look.

This guide covers the use of the Matrix™ cladding in a residential facade application over a seasoned timber or a light-gauge steel frame. Matrix™ cladding is not suitable for sloping walls or on a diagonal orientation.

## DESIGN

### General

All design and construction must comply with the appropriate requirements of the current National Construction Code (NCC) and other applicable regulations and standards.

### Responsibility

The specifier or other party responsible for the project must ensure that the details in this specification are appropriate for the intended application and that additional detailing is performed for specific design or any areas that fall outside the scope of this specification.

### Slab and footings

The slab and footings on which the building is situated must comply with AS 2870 'Residential slabs and footings – Construction' and the requirements of the National Construction Code (NCC).

### Ground clearances

Install James Hardie™ external cladding with a minimum 150mm clearance to the earth on the exterior of the building or in accordance with local building codes if greater than 150mm is required.

Maintain a minimum 50mm clearance between James Hardie™ external cladding and roofs, decks, paths, steps and driveways.

Adjacent finished grade must slope away from the building in accordance with local building codes, typically a minimum slope of 50mm minimum over the first metre.

Do not install external cladding such that it may remain in contact with standing water.

### NOTE

Greater clearance may be required in order to comply with termite protection provisions, see below for more information.

### Termite Protection

The National Construction Code (NCC) specifies the requirements for termite barriers. Where the exposed slab edge is used as part of the termite barrier system, a minimum of 75mm of the exposed slab edge must be visible to permit ready detection of termite entry.

## MOISTURE MANAGEMENT

### General

It is the responsibility of designer or specifier to identify moisture related risks associated with any particular building design. Wall construction design must effectively manage moisture, accounting for both the interior and exterior environments of the building, particularly in buildings that have a higher risk of wind driven rain penetration or that are artificially heated or cooled. In addition all wall openings, penetrations, junctions, connections, window sills, heads and jambs must incorporate appropriate flashing and waterproofing.

Materials, components and their installation that are used to manage moisture in framed wall construction must, at a minimum, comply with the requirements of relevant standards and the National Construction Code (NCC).

### Weather barrier

A suitable water control membrane must be installed under James Hardie™ cladding in accordance with the AS/NZS 4200.2 'Pliable building membranes and underlays – Installation' and NCC requirements.

James Hardie has tested and certified the use of HardieWrap™ weather barrier for climate zones 2-8 within Australia. HardieWrap™ weather barrier is a Class 4 vapour permeable membrane that delivers a triple-shield of protection to help against external weather penetration, internal condensation management and external heat penetration through its safe-glare reflective layer.

If using an alternate product in lieu of HardieWrap™ weather barrier or the project is located in a hot humid area (Climate Zone 1), the designer must ensure that the product is fit for purpose and it has the following classification in accordance with AS/NZS 4200.1:2017 'Pliable building membranes and underlays – Materials':

WEATHER BARRIER CLASSIFICATION		
CLIMATE ZONES	WATER BARRIER	VAPOUR PERMEANCE
2-8	High	Vapour permeable (Class 3 or 4)
1		Vapour Barrier (Class 1 or 2)

Soft compressible insulation installed between the front of the wall studs and directly behind the external cladding can cause installation issues and is thus not recommended.

### Flashing

All wall openings, penetrations, intersections, connections, window sills, heads and jambs must be flashed prior to cladding installation.

## FRAMING

### General

Frame set-out and construction is an important aspect to consider when planning the installation of Matrix™ cladding. The way you install the panels will affect the way you build the frame. Matrix™ panels and cavity trim are installed either on or off stud, refer to Figures 4 and 5.

When installing on stud, the vertical panel joints are located centrally over the cavity trim. For this method of installation it is important that the stud set-out accurately matches the vertical joint locations.

Alternatively, for the off-stud installation method, noggings must be installed at 800mm maximum centres, see Figure 5. The noggings must be aligned with the exterior plane of the frame to ensure that a flush surface is provided to accommodate the installation of the cavity trim. Off stud fixing is not suitable in high wind loads, see Table 1. This table specifies the maximum stud spacings for Matrix cladding for Australian wind load classifications of AS 4055 'Wind Loads for Housing'.

### Timber

Use of timber framing must be in accordance with AS 1684 - 'Residential timber-framed construction' and the framing manufacturer's specifications.

Use only seasoned timber. Unseasoned timber must not be used because it is prone to shrinkage and can cause sheets and frames to move.

'Timber used for house construction must have the level of durability appropriate for the relevant climate and expected service life and conditions including exposure to insect attacks or to moisture, which could cause decay.'

Reference AS 1684.2 'Residential timber-framed construction'.

Stud framing members must be a minimum of 70x35mm,

### Steel

Use of steel framing must be in accordance with NASH standard for Residential and Low-Rise Steel Framing **Part 1: Design Criteria** and the framing manufacturer's specifications. Framing members must have a base metal thickness (BMT) between 0.55 to 1.6mm. The steel framing must have the **appropriate level** of durability required to prevent corrosion.

Framing members must have a Base Metal Thickness (BMT) between 0.55 to 1.6mm. The steel framing must have the appropriate level of durability required to prevent corrosion. Stud framing members must be a minimum of 64x35mm.

### Thermal Break

For steel frames, it's a building code requirement to install a thermal break behind direct fixed cladding. For information relating to the suitability of James Hardie's HardieBreak™ thermal strip, refer to the HardieBreak™ Installation Guide at [www.jameshardie.com.au](http://www.jameshardie.com.au)

### Tolerances

Ensure frame is square and work from a central datum line. Frames must be straight and true to provide a flush face to receive the panels.

A suggested maximum tolerance of between 3mm and 4mm in any 3000mm length of frame will give best results, see Figure 1. Matrix™ cladding will not straighten excessively warped or distorted frames and any warping may still be visible after the cladding is applied.



FIGURE 1 FRAME STRAIGHTNESS

## FASTENERS

### General

Suitable type of fasteners and spacings are provided on the following pages for both the cavity trim and Matrix™ panels. All fasteners specified should be driven flush as shown in Figure 2.

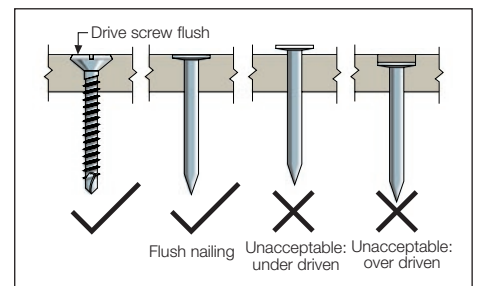

FIGURE 2 NAIL FASTENER DEPTH

Screw fasteners should be screwed as close as possible to the stud corners to avoid deflection of the stud flange.

### Fastener durability

Fasteners must have the appropriate level of durability required for the intended project. This is of particular importance in coastal areas, areas subject to salt spray and other corrosive environments. Fasteners must be fully compatible with all other materials that they are in contact with to ensure the durability and integrity of the assembly. Contact fastener manufacturers for more information.

## PREPARATION

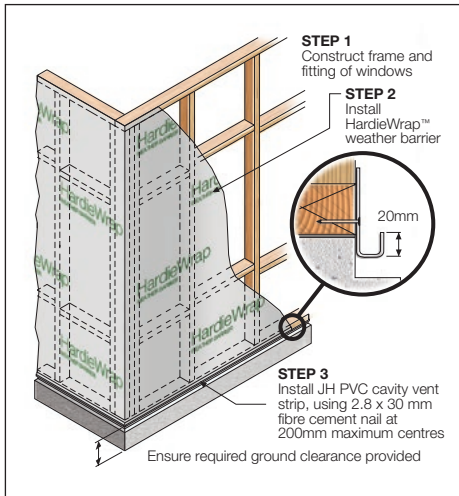

FIGURE 3 PREPARATION

### NOTE

Generally, external and internal corners have additional framing requirements. Refer to the external and internal corner details for more information.

## CAVITY TRIM INSTALLATION

### General

The cavity trim is installed vertically over the HardieWrap™ weather barrier to either timber or metal stud wall frames. The cavity trim may be installed either on or off stud, refer to framing section for more information and Figures 4 and 5.

### OPTION 1:

#### On-stud fixing

For on-stud fixing the cavity trim is installed directly to stud over the HardieWrap™ weather barrier, see Figure 4. For fastener and stud spacings, refer to Table 1.

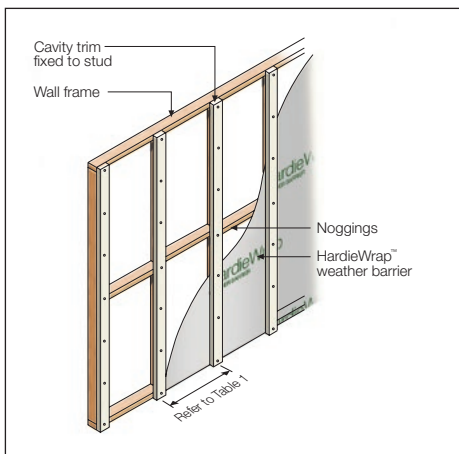

FIGURE 4 ON-STUD FIXING

### OPTION 2:

#### Off-stud fixing

The cavity trim can be installed off-stud over the HardieWrap™ weather barrier. It is important that horizontal supports (noggings) are installed at a maximum of 800mm vertical centres. A specified fastener is fixed at the intersection of every support, see Figure 5. For cavity trim and stud spacings, refer to Table 1.

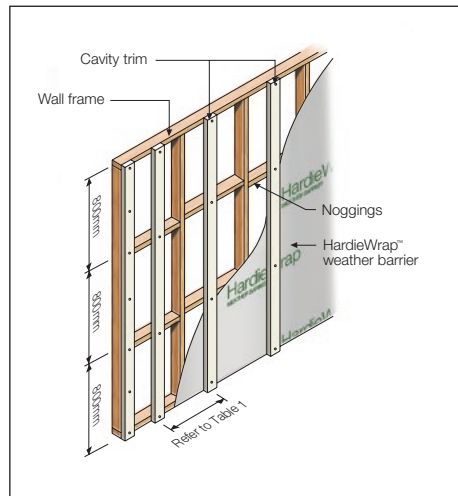

FIGURE 5 OFF-STUD FIXING

### Layout

Planning the layout of the cavity trim and the Matrix panels is an essential part of installation to ensure a professional finish.

Datum lines should be set-up and used to ensure the edges of the cavity trim and Matrix™ panels are square. Datum lines can include the edges of windows, doors and building corners, see Figure 6.

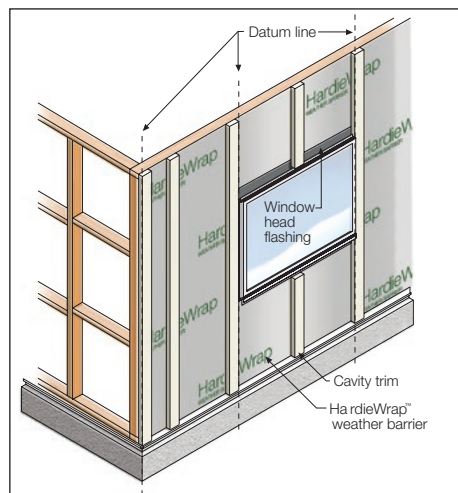

FIGURE 6 PANEL LAYOUT

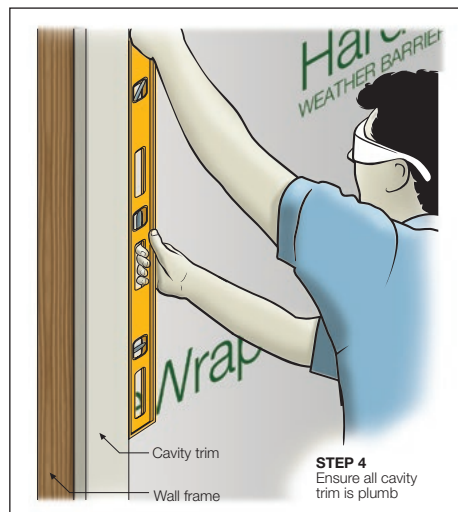

FIGURE 7 PLUMB CAVITY TRIM

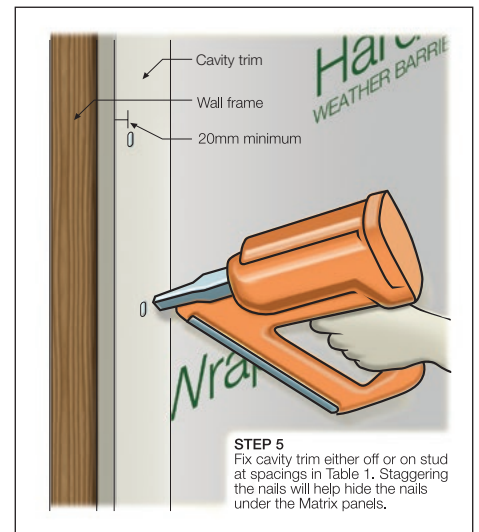

FIGURE 8 FIXING CAVITY TRIM

Ensure the cavity trim butts up to the JH PVC vent strip. Do not insert the cavity trim into the JH PVC vent strip.

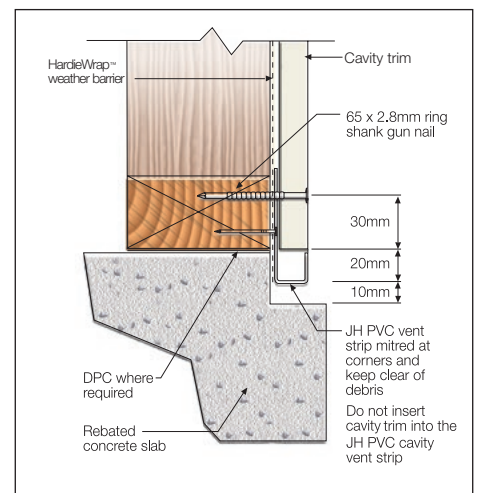

FIGURE 9A SLAB EDGE DETAIL

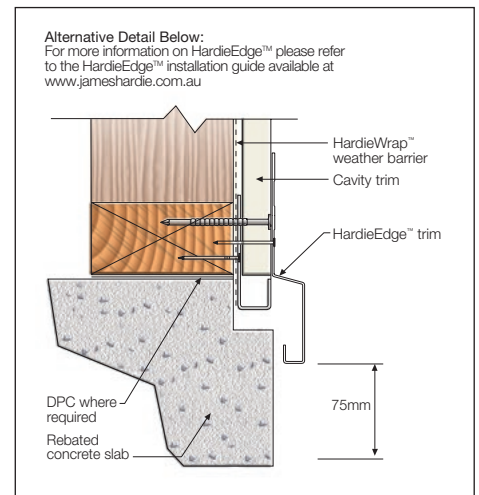

FIGURE 9B ALTERNATIVE SLAB EDGE DETAIL

Alternative Detail Below:  
For more information on HardieEdge™ please refer to the HardieEdge™ installation guide available at [www.jameshardie.com.au](http://www.jameshardie.com.au)

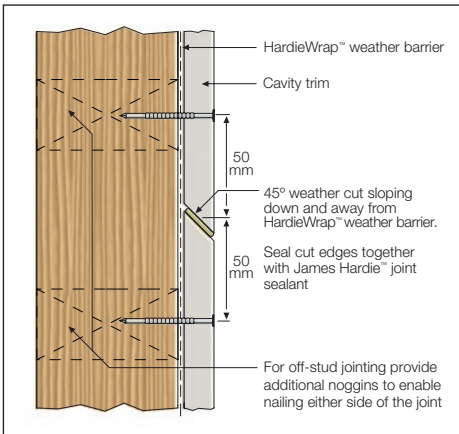

FIGURE 10 CAVITY TRIM BUTT DETAIL

### Cavity trim fasteners

For timber frames, use a corrosion resistant 65 x 2.8mm ring shank nail or a 75 x 2.8mm D or round head galvanised smooth shank nail.

For steel framing thickness of 0.5mm – 1.6mm BMT – use 41mm HardieDrive™ screws.

NOTE: Do not fasten within 30mm of the cavity trim ends and within 20mm of the edges.

TABLE 1

MATRIX™ CLADDING DESIGN TABLE					
AS 4055 Wind classification		Can cavity trim be fixed off-stud	Stud & cavity trim spacing (mm)	Cavity trim fastener spacing (mm)	Matrix panel fastener spacing (mm)
Non-cyclonic	Cyclonic				
<b>ALL FASTENERS EXCEPT BRAD NAILS</b>					
N1, N2, N3	C1	YES	600	300	200
N4	C2	NO	600	200	200
N5	C3	NO	400	200	200
N6	C4	NO	400	200	150
<b>BRAD NAILS ONLY</b>					
N1, N2		YES	600	300	200
N3	C1	YES	600	300	150**
N4	C2	NO	N/A	N/A	N/A
N5	C3	NO	N/A	N/A	N/A
N6	C4	NO	N/A	N/A	N/A

\* In the case of fixing the cavity trim off stud, the fastener spacing will be at each support i.e. a maximum of 800mm centres, see Figure 5.

\*\*If the C25 SS Brad nail is used, the spacing may be increased to 200mm.

### JH BACKING STRIP INSTALLATION

#### General

At horizontal panel joints, the JH backing strip is bonded to the back of the Matrix™ panels to form a socket to which the next course of panels are fixed over. The lower side of the JH backing strip can be bonded using either James Hardie™ joint sealant or double sided backing tape, see Figures 11 and 12.

Ensure all surfaces are free of dust and grime.

#### OPTION 1:

##### Joint sealant option

This method involves applying a continuous bead of James Hardie™ joint sealant to the lower flange of the JH backing strip, see Figure 11.

#### NOTE:

The sealant applied to the backing strip below the stop must be fully cured before the panel is installed.

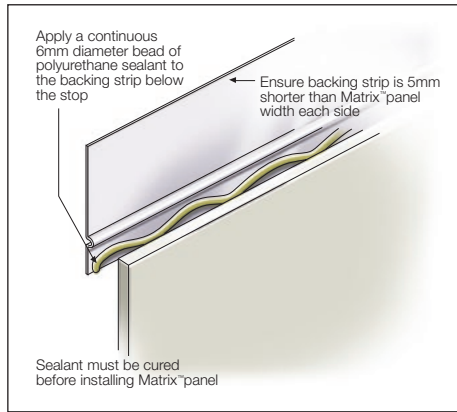

FIGURE 11 JOINT SEALANT OPTION 1

#### OPTION 2:

##### Double sided backing tape option

This method involves applying a continuous strip of 3M 12.7mm wide 4905VHB or Henkel C3 12mm double sided tape to the lower side of the JH backing strip, see Figure 12.

James Hardie recommends the surfaces are cleaned with the 3M HIPA clean 300 adhesive cleaner, in accordance with the manufacturer's recommendations.

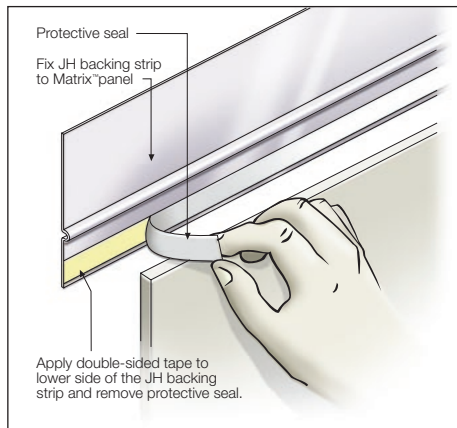

FIGURE 12 DOUBLE SIDED BACKING TAPE OPTION 2

When the panels are ready to be installed, apply James Hardie™ joint sealant behind the JH backing strip and a continuous filler of James Hardie™ joint sealant along the top edges of the panel, see Figure 13. This detail is applicable for both the sealant and double sided backing tape options.

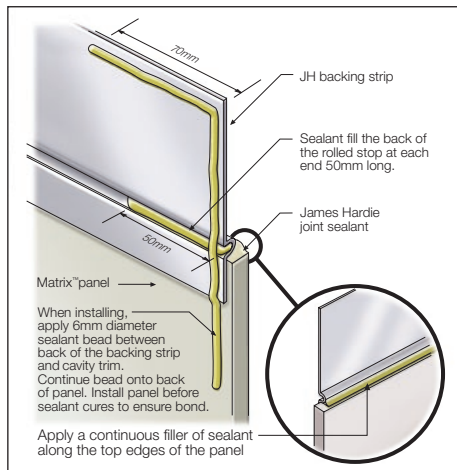

FIGURE 13 SEALING JH BACKING STRIP END DETAIL

### MATRIX™ PANEL INSTALLATION

Note: You must ensure the product is of acceptable quality prior to installation, see Important Note 3.

#### General

The Matrix™ panels must be fixed to the cavity trim. The Matrix™ panels can be installed in a horizontal or vertical orientation.

The panels are installed with a 10mm expressed joint between adjacent panels, vertically and horizontally.

When installing the Matrix™ panels, the clear surface of the Matrix™ panel faces the frame.

In order to seal cut edges or sanded patches, two coats of an appropriate primer should be applied at the time of cutting or sanding compatible with finish coating eg. Watty's Kill Rust Heavy Duty Primer, Dulux AcraPrime 501/1 (water based) or equivalent.

The following installation steps outline the fixing of the Matrix™ panels to the cavity trim. Also refer to Figures 19-22 for further information.

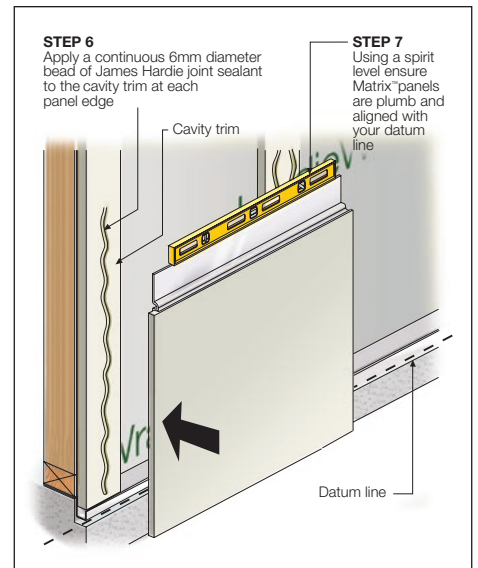

FIGURE 14 INSTALL FIRST PANEL

Figure 15 outlines the fastener spacings into the Matrix™ cladding.

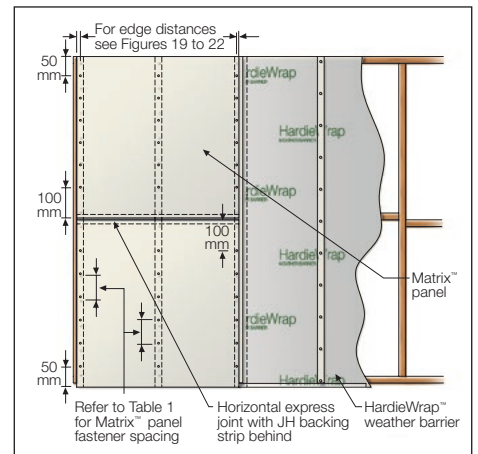

FIGURE 15 MATRIX PANEL FASTENERS

### Matrix™ panel fasteners

The following fixing options are used to fix the Matrix panels to the cavity trim (also see Figures 19-22):

1. C25mm 16 gauge or 25 DA 304 stainless steel brad nails.
2. 2.8x30mm corrosion resistant fibre cement nails, 2.6 x 32mm galvanised or stainless steel twist shank nail with a minimum round head diameter of 5.3mm.
3. 8-10 x 25 stainless steel countersunk chipboard screw square drive / needle point screw.
4. 25mm wafer, pan or hex head stainless steel needle point screws.

NOTE: When using brad nails ensure that brad nails are not used in high wind areas, see Table 1.

In all options, a continuous bead of James Hardie™ joint sealant is applied to the cavity trim to fix the Matrix™ panel to the cavity trim, see Figure 16.

For screw fasteners, a clearance hole must be created using a 6mm masonry drill.

For countersunk screws, the fastener must also be countersunk 2.5 to 3mm below the Matrix™ panel's surface, see Figure 21. The countersunk fastener is then flushed finished with epoxy and then with James Hardie™ base coat. Use only proven epoxies for this application, i.e. Megapoxy P1 or Hilti CA 125. Where the temperature is below 15°, use Hilti CA 273.

For exposed head screws a JH facade washer must be inserted between the panel and the exposed head fastener, see Figure 22.

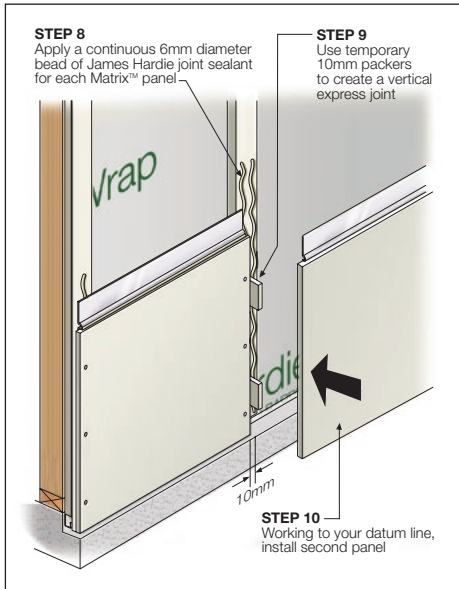

FIGURE 16 INSTALL ADJACENT PANEL

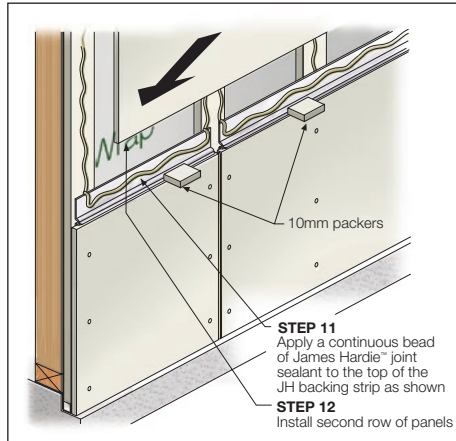

FIGURE 17 INSTALL NEXT COURSE OF PANELS

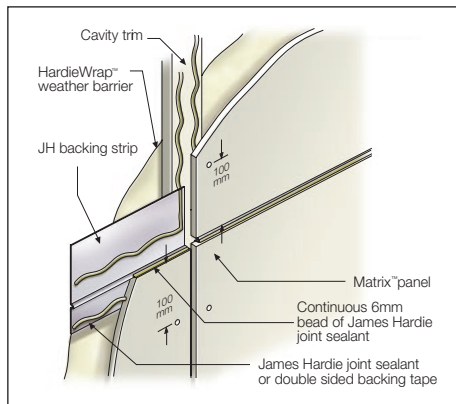

FIGURE 18 JOINT SEALANT PREPARATION

### FASTENER FIXING OPTIONS

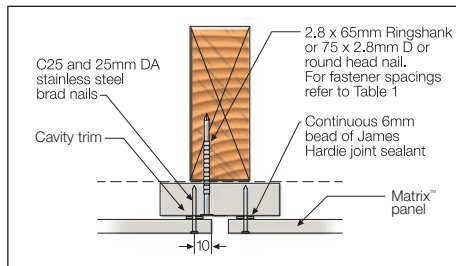

FIGURE 19 BRAD NAIL OPTION 1

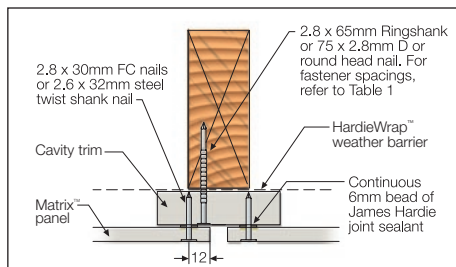

FIGURE 20 STANDARD NAIL OPTION 2

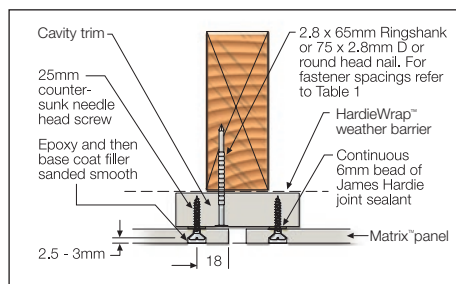

FIGURE 21 COUNTERSUNK SCREW OPTION 3

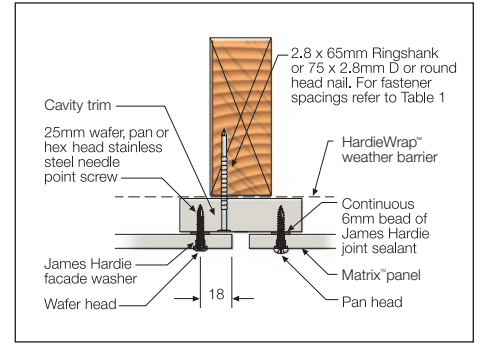

FIGURE 22 EXPOSED HEAD OPTION 4

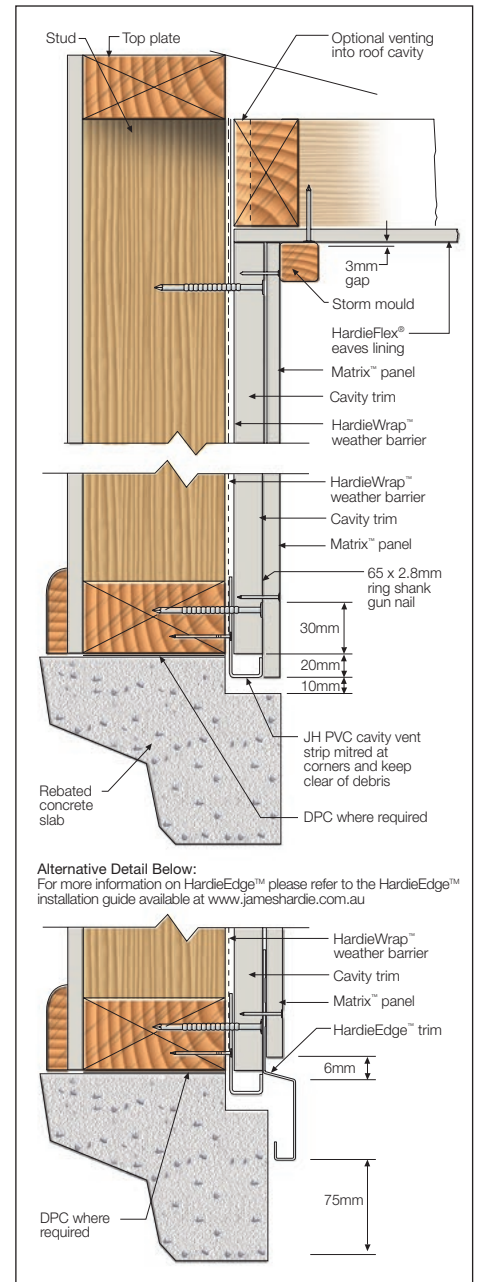

FIGURE 23 SLAB/EAVES DETAIL

Alternative Detail Below:  
For more information on HardieEdge™ please refer to the HardieEdge™ installation guide available at [www.jameshardie.com.au](http://www.jameshardie.com.au)

## WINDOWS/PARAPETS

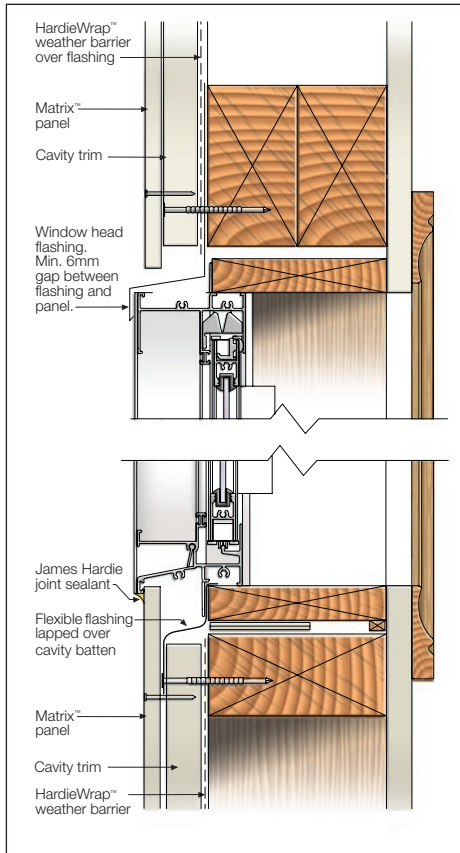

FIGURE 24 WINDOW HEAD/SILL DETAIL

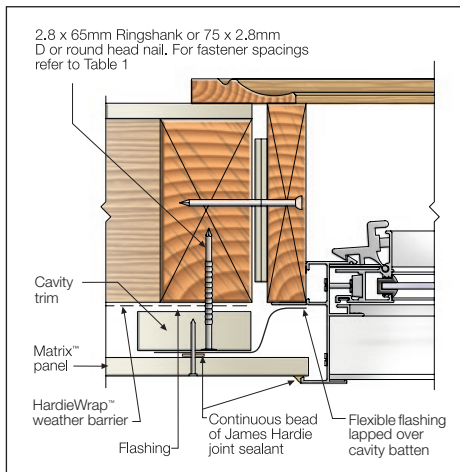

FIGURE 25 WINDOW JAMB DETAIL

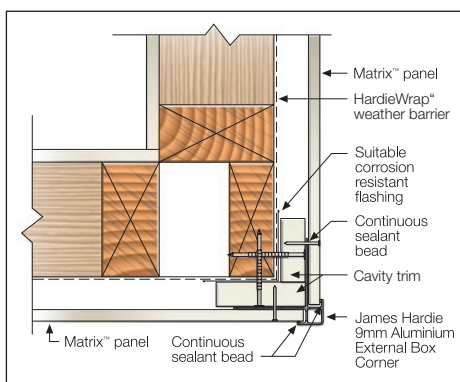

FIGURE 26 MATRIX EXTERNAL BOX CORNER DETAIL

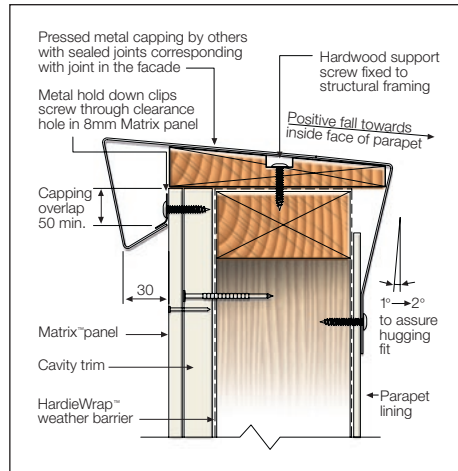

FIGURE 27 PARAPET CAPPING DETAIL

## EXTERNAL CORNER DETAIL

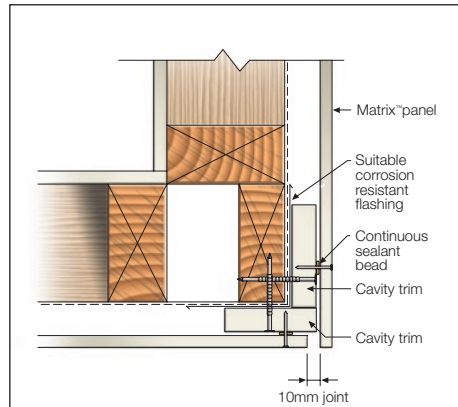

FIGURE 28 EXTERNAL CORNER DETAIL

## INTERNAL CORNER DETAIL

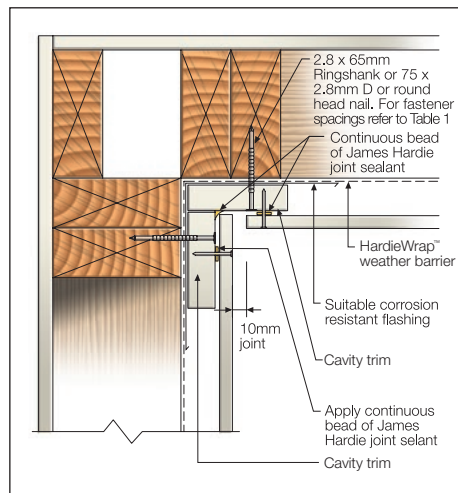

FIGURE 29 INTERNAL CORNER DETAIL

## JUNCTION DETAILS

When using solid floor joists, cavity trim must not run continuously from lower floor to upper floor level. There must be a vertical 15mm gap between the cavity trim at the floor level junction to allow for timber movement, refer to Figure 30.

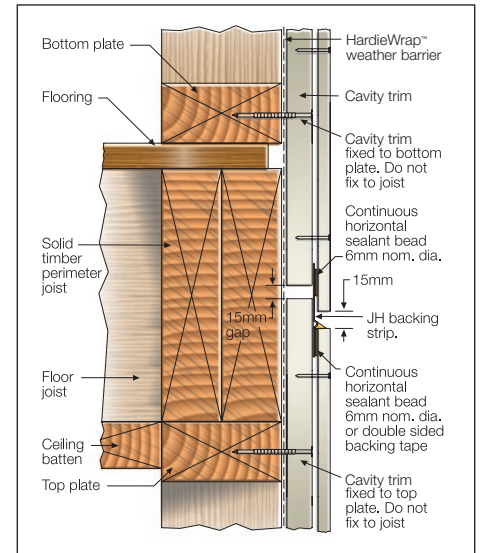

FIGURE 30 FLOOR LEVEL JUNCTION

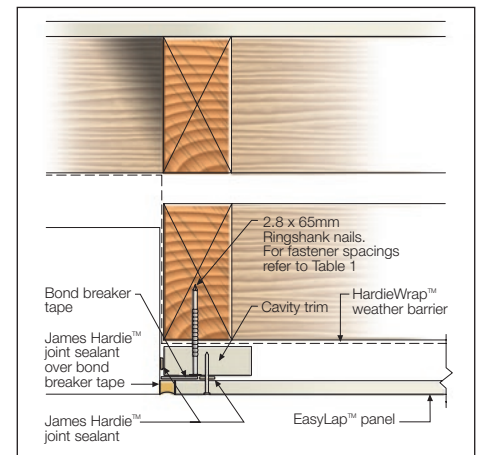

FIGURE 31 ABUTMENT DETAIL

## NOTES

- To cover the 15mm gap in the cavity trim at the vertical expressed joint, use a section of JH backing strip over joint and adequately seal it in place to prevent moisture entry.
- Where solid joists are not used, consideration should be given to allow for shrinkage movement across joint. One option is to leave a 5mm sealed gap between cavity trim.

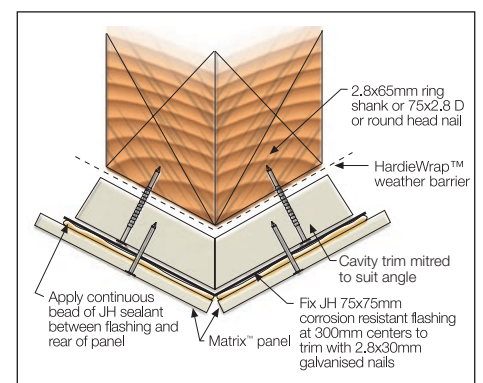

FIGURE 32 ANGLED CORNER

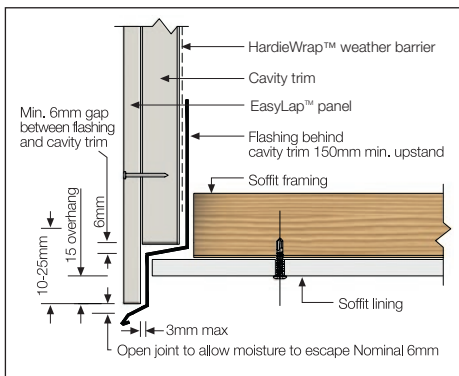

FIGURE 33 FACADE/SOFFIT JUNCTION

## FIRE RATED WALLS

Matrix™ clad walls can achieve fire ratings of 60/60/60 and 90/90/90 when constructed with additional fire rated linings as specified in the James Hardie's Fire and Acoustically Rated Walls Design Guide and Acoustically Rated Walls Technical Specification.

Furthermore, as the Matrix™ cladding consists of cavity trim installed over the wall frame, the fire and water resistant plasterboard must be installed behind the HardieWrap™ weather barrier and cavity trim. It must not be directly installed behind the Matrix™ panels. The length of the fasteners fixing the cavity trim to the wall frame will need to take into account the thickness of the fire and water resistant plasterboard.

## FINISHES

### General

Refer to the project specification for paint requirements. Matrix™ cladding and exposed cavity trim must be painted within 3 months of being fixed.

The rear of the Matrix™ panel must not be left permanently exposed to direct sunlight.

In order to seal cut edges or sanded patches, two coats of an appropriate primer should be applied at the time of cutting or sanding compatible with finish coating e.g. Watty! Kill Rust Heavy Duty Primer, Dulux AcraPrime 501/1 (water based) or equivalent.

James Hardie recommends the application of two coats minimum of a quality acrylic paint over the pre-primed Matrix™ panels and the exposed cavity trim in accordance with the paint manufacturer's specifications. Painting selection and specifications is dependant on the paint chosen. Gloss paints are not recommended.

### Coastal areas

In areas within 1km of a coastal area or corrosive environment, the Matrix™ panels must be painted immediately after fixing sheets, to minimise build up of contamination on the heads of the fasteners, as it may lead to fastener corrosion. Also refer to maintenance requirements and fastener section for more information.

Refer to the paint and fastener manufacturer for further information, suitable products and details of their warranty.

## Sealants

Application and use of sealants must comply with manufacturer's instructions. Sealants, if coated, must be compatible with the paint system. James Hardie recommends the use of James Hardie™ joint sealant, which is a paintable polyurethane sealant.

## STAINING

Stains containing linseed oil are specifically designed for wood and may not be suitable for James Hardie™ cladding products, primed or un-primed.

Semi-transparent stains can vary in uniformity of appearance depending on method of application and conditions and will require a high level of skill and craftsmanship to achieve a uniform appearance. Clear coats have not proven durable in exterior exposure and James Hardie considers them a maintenance item that may require application of a refurbishing sealer at regular intervals. James Hardie does not warrant the appearance or durability of semi-transparent stains and clear coats.

## MAINTENANCE

The extent and nature of maintenance will depend on the geographical location and exposure of the building. As a guide, it is recommended that basic normal maintenance tasks shall include but not be limited to:

- Washing down exterior surfaces every 6-12 months\*
- Periodic inspections should be made to ensure fasteners are adequately securing the panels to framing.
- Re-applying of exterior protective finishes\*
- Maintaining the exterior envelope and connections including joints, penetrations, flashings and sealants that may provide a means of moisture entry beyond the exterior cladding.
- Cleaning out gutters, blocked pipes and overflows as required.
- Pruning back vegetation that is close to or touching the building.

\*Refer to your paint manufacturer for washing down and recoating requirements related to paint performance.

## PRODUCT INFORMATION

### Material

The basic composition of James Hardie™ building products is Portland cement, ground sand, cellulose fibre, water and proprietary additives.

James Hardie™ building products are manufactured AS/NZS 2908.2 'Cellulose-Cement Products-Flat Sheet'. These are also compliant with equivalent standard ISO 8336 'Fibre-cement flat sheets - Product specification and test methods'. For product classification refer to the relevant Physical Properties Data Sheet.

### Durability

#### Resistance to moisture/rotting

Matrix™ panels and cavity trim have demonstrated resistance to permanent moisture induced deterioration (rotting) by passing the following tests in accordance with AS/NZS 2908.2:

- Water permeability (Clause 8.2.2)
- Warm water (Clause 8.2.4)
- Heat rain (Clause 6.5)
- Soak dry (Clause 8.2.5)

#### Resistance to termite attack

Based on testing completed by CSIRO Division of Forest Products and Ensis Australia James Hardie building products have demonstrated resistance to termite attack.

#### Resistance to Fire

Matrix™ cladding is suitable where non-combustible materials are required in accordance with C1.9 of the Building Code of Australia.

James Hardie™ building products have been tested by CSIRO in accordance with AS/NZS 3837 and are classified as conforming to Group 1 material (highest and best result possible), with an average specific extinction area far lower than the permissible 250m<sup>2</sup>/kg, as referenced in Specification C1.10a of the National Construction Code (NCC).

### Alpine regions

In regions subject to freeze/thaw conditions, all James Hardie™ fibre cement external cladding must be installed and painted in the warmer months of the year where the temperature does not create freeze and thaw conditions or paint issues. The cladding must be painted immediately after installation. In addition, fibre cement cladding must not be in direct contact with snow and/or ice build up for extended periods, e.g. external walls in alpine regions subject to snow drifts over winter.

Furthermore, a reputable paint manufacturer must be consulted in regards to a suitable product, specifications and warranty. The paint application must not be carried out if the air temperature or the substrate temperature is outside the paint manufacturer's recommendation including the specified drying temperature range.

James Hardie™ external cladding products are tested for resistance to frost in accordance with AS/NZS 2908.2 Clause 8.2.3.

Ask James Hardie™  
Call 13 11 03  
www.jameshardie.com.au



# Notes

# Notes





**For information and advice  
call 13 11 03 | [jameshardie.com.au](https://jameshardie.com.au)**

**Australia August 2021**

© 2021 James Hardie Australia Pty Ltd ABN 12 084 635 558  
™ and © denote a trademark or registered mark owned by James Hardie Technology Limited.

