



Installation Guide

Axon™ Cladding

EXTERIORS

Australia September 2021

Make sure your information is up to date.

When specifying or installing Hardie™ products, ensure that you have the current technical information and guides. If in doubt, or you need more information, visit www.jameshardie.com.au or Ask James Hardie™ on 13 11 03.



Installation Guide

Made in Australia and New Zealand

IMPORTANT NOTES

1. Failure to install, finish or maintain this product in accordance with applicable building codes, regulations, standards and James Hardie's written application instructions may lead to personal injury, affect system performance, violate local building codes, and void James Hardie's product warranty.
2. All warranties, conditions, liabilities (direct, indirect or consequential) and obligations whether arising in contract, tort or otherwise other than those specified in the James Hardie's product warranty are excluded to the fullest extent allowed by law. For James Hardie's product warranty information and disclaimers about the information in this guide, refer to www.jameshardie.com.au.
3. The builder must ensure the product meets aesthetic requirements before installation. James Hardie™ will not be responsible for rectifying aesthetic surface variations following installation.
4. Make sure your information is up to date. When specifying or installing James Hardie's fibre cement products, ensure you have the current guide. If in doubt, or you need more information, visit www.jameshardie.com.au or Ask James Hardie™ on 13 11 03.

AXON™ CLADDING SHEET SIZES (mm)

Pre-primed with vertical grooves. There is a ship lap edge joint along the two long edges and square edges along the short edges. The grooves are nominally 2mm deep and 10mm wide. Sheet weighs approximately 12kg/m² in equilibrium.

AXON™ cladding	LENGTH	WIDTH	THICKNESS	MASS (kg)	SHEETS PER PACK	PRODUCT CODE
Axon™ cladding 133 Smooth	2450	1200	9	36	30	403931
	2750	1200	9	40	30	403932
	3000	1200	9	44	30	403933
	3600	1200	9	52	30	404979
Axon™ cladding 133 Grained	3000	1200	9	44	30	404512
Axon™ cladding 400 Smooth	2450	1200	9	36	30	404417
	2750	1200	9	40	30	404418
	3000	1200	9	44	30	404419

*All dimensions and masses are approximate and subject to manufacture tolerances.

ACCESSORIES / TOOLS SUPPLIED BY JAMES HARDIE™

ACCESSORIES	DESCRIPTION	ACCESSORIES	DESCRIPTION
	Hardie™ Drive Screw 41mm Long A class 3 self-tapping wing-tipped screw for fastening to 0.5mm to 1.6mm BMT light gauge steel frames. Part No. 305984 1000 per box		Hardie™ 9mm Aluminium Horizontal h Flashing 3,000mm long A ready to paint aluminium horizontal flashing, to be used with EasyLap™ panel and Axon™ cladding, for horizontal control joints. 5 per pack. Part No. 305613
	Hardie™ Drive Collated Screw 41mm Long A class 3 self-tapping wing-tipped screw for fastening to 0.5mm to 1.6mm BMT light gauge steel frames. Suitable for use in most auto feed screw guns. Part No. 305982 1000 per box		Hardie™ 9mm Aluminium Horizontal h Joints A ready to paint aluminium jointer, used to join the Hardie™ 9mm Aluminium Horizontal h Flashing. 10 per pack. Part No. 305614
	Hardie™ 50mm wide Foam Back Sealing Tape 25mtr long roll A self-adhesive foam tape to help improve water tightness with EasyLap™ panel and Axon™ cladding. It is applied under sheet joints to the Hardie™ Wrap weather barrier along the stud face. 1 each. Part No. 304560		Hardie™ Break Thermal Strip A building code requirement and is installed behind Hardie™ external cladding over metal framing and Hardie™ Wrap weather barrier. Refer to Hardie™ Break thermal strip installation guide. Unit size 43 x 12 x 2750mm. 45 per pack. Part No. 305612
	Hardie™ Joint Sealant General purpose, paintable, exterior grade polyurethane joint sealant. 300ml cartridge/600ml sausage. 20 per box. Part No. 305534/305672		Hardie™ Aluminium Snap on Corner 3,000mm long (2 pieces per set) A ready to paint aluminium extrusion set, to be used with Axon™ cladding, Hardie™ Plank weatherboard and PrimeLine™ weatherboard, at internal and external corner junctions to conceal the board edge. Before inserting outer piece, use pliers to break off teeth along score line. 5 sets per pack. Part No. 305513
	Hardie™ Aluminium Snap on Corner 3,000mm long A ready to paint aluminium extrusion, to be used with EasyLap™ panel and Axon™ cladding, at internal corner junctions to conceal the board edge. 5 per pack. Part No. 305520		Hardie™ 9mm Aluminium External Corner 3,000mm long A ready to paint aluminium extrusion, to be used with EasyLap™ panel and Axon™ cladding, at external corner junctions to conceal the board edge. 5 per pack. Part No. 306100
	Hardie™ 9mm Aluminium External Square Corner 3,000mm long A ready to paint aluminium extrusion, to be used with EasyLap™ panel and Axon™ cladding, at external corner junctions to conceal the board edge. 5 per pack. Part No. 306100		Hardie™ Edge Trim An architectural slab edge solution fabricated from high-quality powder coated aluminium. Base Trim unit size: 3950mm. Also available: Base Trim 4 per pack. Part No. 305911 Base Trim Joints 12 per pack. Part No. 305912 Internal Corner 4 per pack. Part No. 305913 External Corner 4 per pack. Part No. 305914
	Hardie™ 75x75mm Colorbond Corner Flashing 3,000mm long A Colorbond corner flashing for use behind cladding at internal and external corners. 5 per pack. Part No. 305564	TOOLS	
COMPONENTS NOT SUPPLIED BY JAMES HARDIE James Hardie recommends the following products for use in conjunction with its Axon™ cladding. James Hardie does not supply these products and does not provide a warranty for their use. Please contact component manufacturer for information on their warranties and further information on their products.			M class or higher vacuum Required to reduce the exposure to respirable dust and crystalline silica.
	Dust-reducing saw with M class or higher vacuum extraction Dust reducing saw with a Hardie™ Blade saw blade. Makita 5057KB Hitachi C7YA		Fibre cement nails 2.8 x 40mm min. class 3 fibre cement nail

* Highly corrosive environments and areas within 1km of the coast require Class 4 or stainless steel coatings. Refer to the fastener manufacturer for recommendations.

WARNING - DO NOT BREATHE DUST AND CUT ONLY IN WELL VENTILATED AREA

James Hardie's fibre cement products contain sand, a source of respirable crystalline silica. **May cause cancer if dust from product is inhaled. Causes damage to lungs and respiratory system through prolonged or repeated inhalation of dust from product.**

Intact fibre cement products are not expected to result in any adverse toxic effects. The hazard associated with fibre cement arises from the respirable crystalline silica present in dust generated by activities such as cutting, rebating, drilling, routing, sawing, crushing, or otherwise abrading fibre cement, and when cleaning up, disposing of or moving dust.

When doing any of these activities in a manner that generates dust, follow James Hardie's instructions and best practices to reduce or limit the release of dust, warn others in the area and consider rotating personnel across the cutting task to further limit respirable silica exposure.

If using a dust mask or respirator, use an AS/NZS1716 P1 filter and refer to Australian/New Zealand Standard 1715:2009 Selection, Use and Maintenance of Respiratory Protective Equipment for more extensive guidance and more options for selecting respirators for workplaces. For further information, refer to our installation instructions and Safety Data Sheets available at www.jameshardie.com.au. FAILURE TO ADHERE TO OUR WARNINGS, SAFETY DATA SHEETS, AND INSTALLATION INSTRUCTIONS MAY LEAD TO SERIOUS PERSONAL INJURY OR DEATH.

JAMES HARDIE RECOMMENDED SAFE WORKING PRACTICES

CUTTING OUTDOORS

1. Position cutting station so wind will blow dust away from the user or others in working area.
2. Warn others in the area to avoid dust.
3. Consider rotating personnel across cutting tasks to further limit respirable silica exposures.
4. Use one of the following methods based on the required cutting rate:
Best • Hardie™ knife • Hand guillotine • Fibreshear
Better • Position the cutting station in a well-ventilated area.
Use a dust reducing circular saw equipped with Hardie™ Blade Saw Blade or comparable fibre cement blade and well maintained M-class vacuum or higher with appropriate filter for capturing fine (respirable) dust. Wear a properly-fitted, approved dust mask or respirator (minimum P1).

CUTTING INDOORS

- Cut only using Hardie™ knife, hand guillotine or fibreshears (manual, electric or pneumatic).
- Position cutting station in a well-ventilated area.

DRILLING/OTHER MACHINING

When drilling or machining you should always wear a P1 dust mask and warn others in the immediate area.

IMPORTANT NOTES

1. For maximum protection (lowest respirable dust production) James Hardie recommends always using best practice cutting methods where feasible.
2. NEVER use a power saw indoors or in a poorly ventilated area.
3. ALWAYS use a dust reducing circular saw equipped with a sawblade specifically designed to minimise dust creation when cutting fibrecement - preferably a sawblade that carries the Hardie™ Blade logo or one with at least equivalent performance - connected to a M class or higher vacuum.
4. NEVER dry sweep - Use wet suppression, or an M class vacuum or higher with appropriate filter.
5. NEVER use grinders.
6. ALWAYS follow tool manufacturers' safety recommendations.
7. ALWAYS wear a properly fitted, approved dust mask, P1 or higher

DUST MASKS AND RESPIRATORS

As a minimum, an AS/NZS1716 P1 respirator must be used when doing any activity that may create dust. For more extensive guidance and options for selecting respirators for workplaces please refer to Australian/New Zealand Standard 1715:2009 "Selection, Use and Maintenance of Respiratory Protective Equipment". P1 respirators should be used in conjunction with the above cutting practices to minimise dust exposure. For further information, refer to Safety Data Sheet (SDS) available at www.jameshardie.com.au. If concern still exists about exposure levels or you do not comply with the above practices, you should always consult a qualified industrial hygienist or contact James Hardie for further information.

STORAGE AND HANDLING

To avoid damage, all James Hardie's fibre cement products should be stored with edges and corners of the product protected from chipping. James Hardie's fibre cement products must be installed in a dry state and protected from weather during transport and storage. The product must be laid flat under cover on a smooth level surface clear of the ground to avoid exposure to water, moisture, etc.

SCOPE

General

This guide covers the use of the Axon™ cladding in a residential facade application over a seasoned timber wall frame or a light-gauge steel frame.

DESIGN

General

All design and construction must comply with the appropriate requirements of the current National Construction Code (NCC) and other applicable regulations and standards.

Responsibility

The specifier or other party responsible for the project must ensure that the details in this specification are appropriate for the intended application and that additional detailing is performed for specific design or any areas that fall outside the scope of this specification.

Slab and footings

The slab and footings on which the building is situated must comply with AS 2870 'Residential slabs and footings – Construction' and the requirements of the National Construction Code (NCC).

Ground clearances

Install Axon™ Cladding with a minimum 150mm clearance to the earth on the exterior of the building or in accordance with local building codes if greater than 150mm is required. Maintain a minimum 50mm clearance between the external cladding and roofs, decks, paths, steps and driveways.

Adjacent finished grade must slope away from the building in accordance with local building codes, typically a minimum slope of 50mm minimum over the first metre.

Do not install external cladding such that it may remain in contact with standing water.

NOTE: Greater clearance may be required in order to comply with termite protection provisions, see below for more information.

Termite Protection

The National Construction Code (NCC) specifies the requirements for termite barriers. Where the exposed slab edge is used as part of the termite barrier system, a minimum of 75mm of the exposed slab edge must be visible to permit ready detection of termite entry.

Structural bracing

Axon™ cladding can be installed to provide wall bracing against lateral forces due to wind. For further information, Ask James Hardie™ on 13 11 03.

Fire rated walls

Axon™ cladding can achieve fire ratings of 60/60/60 and 90/90/90 when constructed with additional fire rated linings as specified in the James Hardie's Fire and Acoustically Rated Walls Design Guide and Construction of Fire and Acoustically Rated Walls Technical Specification.

MOISTURE MANAGEMENT

General

It is the responsibility of designer or specifier to identify moisture related risks associated with any particular building design. Wall construction design must effectively manage moisture, accounting for both the interior and exterior environments of the building, particularly in buildings that have a higher risk of wind driven rain penetration or that are artificially heated or cooled.

In addition all wall openings, penetrations, junctions, connections, window sills, heads and jambs must incorporate appropriate flashing and waterproofing. Materials, components and their installation that are used to manage moisture in framed wall construction must, at a minimum, comply with the requirements of relevant standards and the NCC.

Weather Barrier

A suitable water control membrane must be installed under Hardie™ cladding in accordance with the AS/NZS 4200.2 'Pliable building membranes and underlays – Installation' and NCC requirements.

James Hardie has tested and certified the use of Hardie™ Wrap weather barrier for climate zones 2-8 within Australia. Hardie™ Wrap weather barrier is a Class 4 vapour permeable membrane that delivers a triple-shield of protection to help against external weather penetration, internal condensation management and external heat penetration through its safe-glare reflective layer.

If using an alternate product in lieu of Hardie™ Wrap weather barrier or the project is located in a hot humid area (Climate Zone 1), the designer must ensure that the product is fit for purpose and it has the following classification in accordance with AS/NZS 4200.1:2017 'Pliable building membranes and underlays – Materials':

WEATHER BARRIER CLASSIFICATION		
CLIMATE ZONES	WATER BARRIER	VAPOUR PERMEANCE
2-8	High	Vapour permeable (Class 3 or 4)
1		Vapour Barrier (Class 1 or 2)

Soft compressible insulation installed between the front of the wall studs and directly behind the external cladding can cause installation issues and is thus not recommended.

Flashing

All wall openings, penetrations, intersections, connections, window sills, heads and jambs must be flashed prior to cladding installation.

Accessories

Some Axon™ cladding accessories may require installation prior to fixing of the boards. Refer to the relevant details in this document.

FRAMING

General

The Axon™ cladding is installed vertically to both timber and metal studs.

Framing width at sheet joints must be a minimum of 45mm. Where the studs at sheet joints are less than 45mm wide provide double 35mm wide studs at sheet joints. Ensure double studs are well nailed together and flush at the outside face.

All intermediate support studs must be a minimum of 70 x 35mm for timber and 64 x 35mm deep for metal framing. Maximum stud spacings for Axon™ cladding for wind load classifications of AS 4055 'Wind Loads for Housing' are given in Table 1.

NOTE: Brad nailing option is not suitable in high wind areas, see Tables 1 and 2.

TABLE

MAXIMUM STUD SPACING - AS 4055			
WIND CLASSIFICATION		STUD SPACING (mm)	
Non-Cyclonic	Cyclonic	General areas	1200mm of building edges
ALL FASTENERS EXCEPT BRAD NAILS			
N1, N2, N3	C1	600	600
N4	C2	600	400
N5, N6	C3/C4	400	300
BRAD NAILS ONLY			
N1, N2, N3	C1	600	600
N4	C2	N/A	N/A
N5, N6	C3, C4	N/A	N/A

Timber

Use of timber framing must be in accordance with AS 1684 - 'Residential timber-framed construction' and the framing manufacturer's specifications.

Use only seasoned timber. Unseasoned timber must not be used because it is prone to shrinkage and can cause sheets and frames to move.

'Timber used for house construction must have the level of durability appropriate for the relevant climate and expected service life and conditions including exposure to insect attacks or to moisture, which could cause decay.' Reference AS 1684.2 'Residential timber-framed construction'.

Steel

Use of steel framing must be in accordance with NASH standard for Residential and Low-Rise Steel Framing Part 1: Design Criteria and the framing manufactures specifications. Framing members must have a base metal thickness (BMT) between 0.55 to 1.6mm. The steel framing must have the appropriate level of durability required to prevent corrosion.

Thermal Break

For steel frames, it's a building code requirement to install a thermal break behind direct fixed cladding. For information relating to the suitability of Hardie™ Break thermal strip, refer to the Hardie™ Break Installation Guide at www.jameshardie.com.au

Tolerances

Ensure frame is square and work from a central datum line. Frames must be straight and true to provide a flush face to receive the sheeting. A suggested maximum tolerance of between 3mm and 4mm in any 3000mm length of frame will give best results. Axon™ cladding will not straighten excessively warped or distorted frames and any warping may still be visible after the cladding is applied.



FIGURE 1 FRAME STRAIGHTNESS

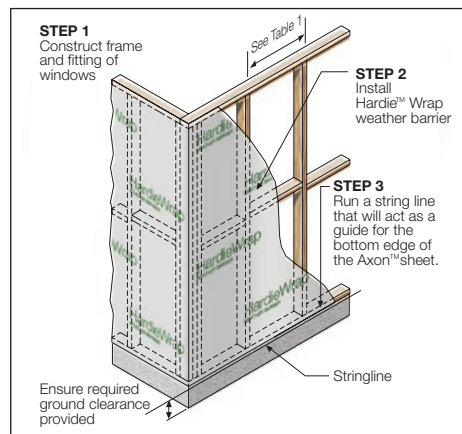

FIGURE 2 PREPARATION

PREPARATION

NOTES

Generally, external and internal corners have additional framing requirements. Refer to the external and internal corner details for more information.

FASTENERS

General

All fasteners specified should be driven flush as shown in Figure 3.

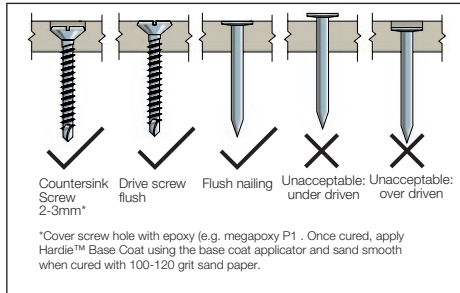

FIGURE 3 NAIL FASTENER DEPTH

Fasteners should be screwed as close as possible to the stud corners to avoid deflection of the stud flange, see Figure 4.

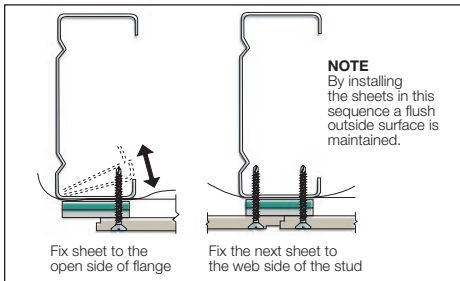

FIGURE 4 SCREW FASTENING

Fastener Durability

Fasteners must have the appropriate level of durability required for the intended project. This is of particular importance in coastal areas, areas subject to salt spray and other corrosive environments. Fasteners must be fully compatible with all other materials that they are in contact with to ensure the durability and integrity of the assembly. Contact fastener manufacturers for more information.

Timber frames

For timber frames, use a ND 50mm 14 gauge 304 stainless steel brad nail. See Table 2 for suitability. Alternatively, a 2.8 x 40mm galvanised fibre cement nail.

NOTE: When using brad nails:

- Do not over drive the fasteners into the sheet.
- Ensure that brad nails are not used in high wind areas, see Tables 1 and 2.
- Where twisting/warping of the top or bottom timber plates may occur, consideration should be given to either using fibre cement nails or closing up brad nail spacings at the plates.

Steel frames

For steel framing thickness of 0.5mm – 1.6mm BMT – use 41mm Hardie™ Drive screws. Refer to thermal break section of this guide. Table 2 below outlines the maximum sheet fastener spacings:

TABLE 2

MAXIMUM SHEET FASTENER SPACINGS-AS 4055			
WIND CLASSIFICATION		FASTENER SPACING (mm)	
Non-Cyclonic	Cyclonic	General areas	1200mm of building edges
ALL SPECIFIED FASTENERS EXCEPT BRAD NAILS			
N1, N2, N3	C1	200	200
N4	C2	200	200
N5, N6	C3/C4	200	150
BRAD NAILS ONLY			
N1, N2, N3	C1	150	150
N4	C2	N/A	N/A
N5, N6	C3, C4	N/A	N/A

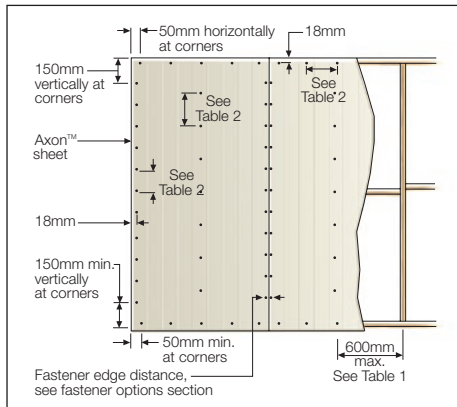

FIGURE 5 SHEET FASTENING SPACING

SHEET INSTALLATION

Note: You must ensure the product is of acceptable quality prior to installation, see Important Note 3.

Axon™ cladding must be installed vertically with all sheet edges fully supported. Sheet joints must coincide with the centre line of the framing member.

At every vertical sheet joint, a 50mm foam back sealing tape is applied under the shiplap vertical joint and in front of the Hardie™ Wrap weather barrier, see Figure 6. Unless its a steel frame and Figure 12 is followed.

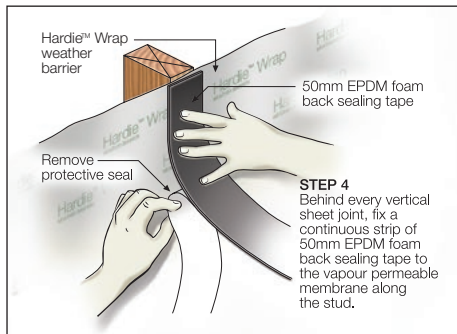

FIGURE 6 APPLY FOAM TAPE

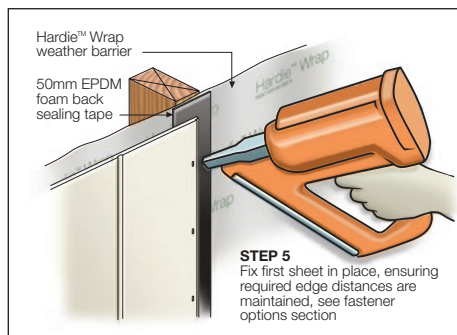

FIGURE 7 FIX FIRST SHEET

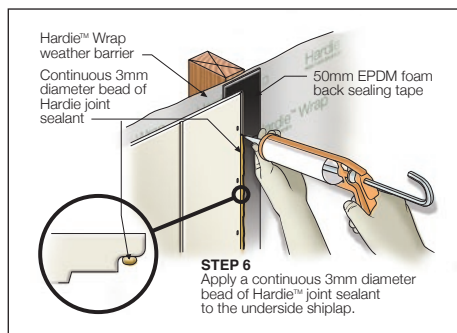

FIGURE 8 APPLY JOINT SEALANT

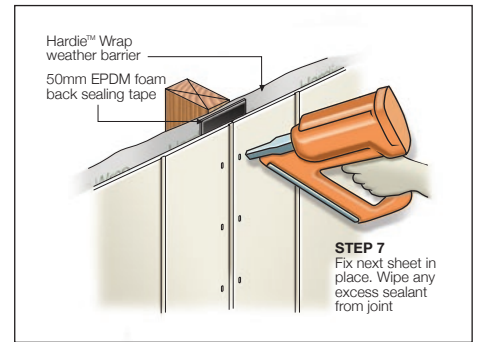

FIGURE 9 FIX NEXT SHEET

FASTENER OPTIONS

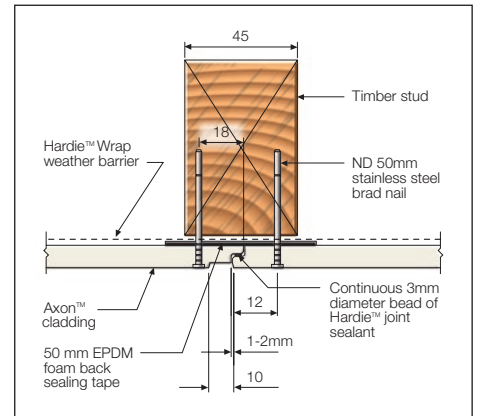

FIGURE 10 BRAD NAIL FIXING

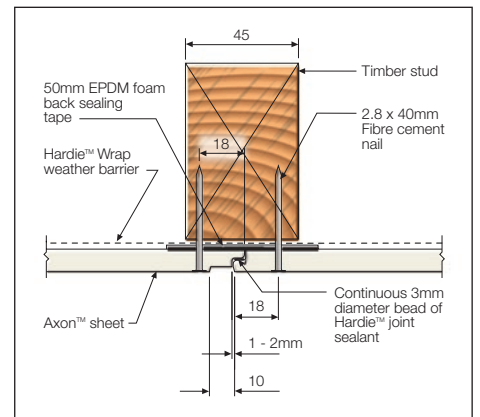

FIGURE 11 FIBRE CEMENT NAIL FIXING

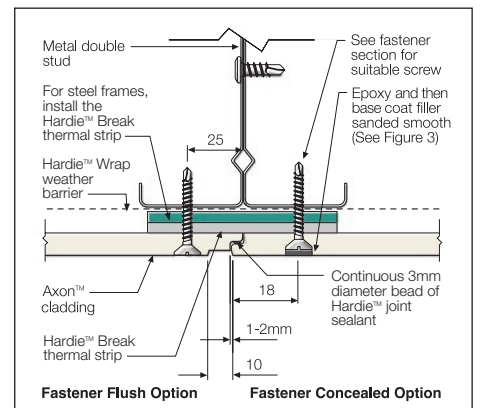

FIGURE 12 SHEET JOINT ON STEEL: FLUSH AND CONCEALED FIXING OPTIONS

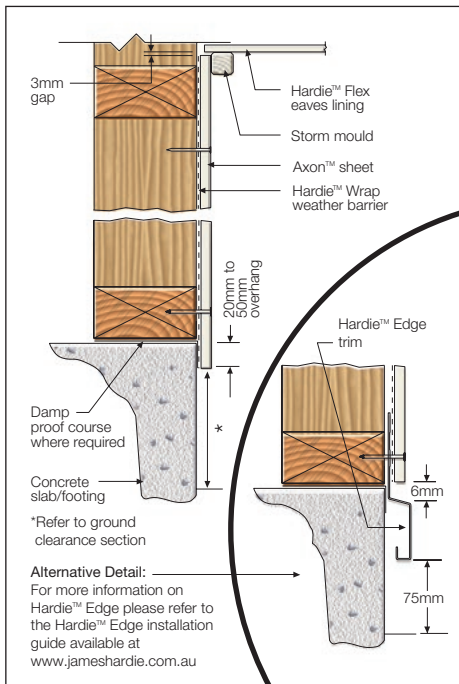

FIGURE 13 SLAB/EAVE JUNCTION DETAIL

WINDOW DETAILS

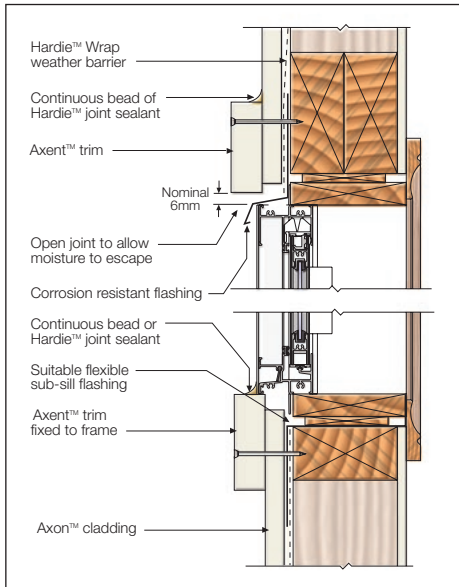

FIGURE 14 WINDOW HEAD AND SILL - TRIM

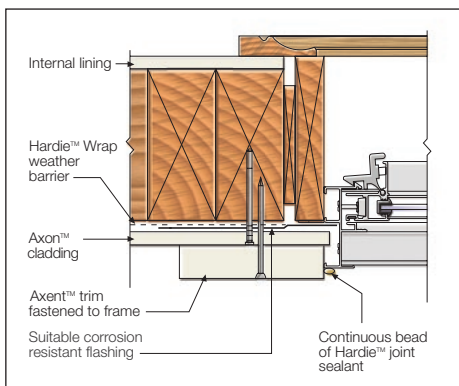

FIGURE 15 WINDOW JAMB - TRIM

EXTERNAL CORNER DETAILS

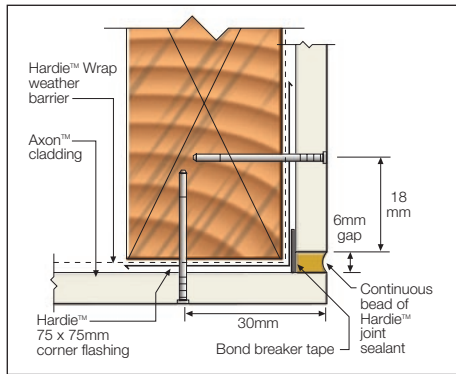

FIGURE 16 SEALANT FILL OPTION

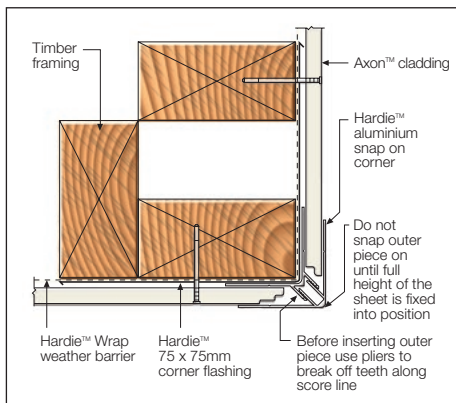

FIGURE 17 SNAP ON CORNER OPTION

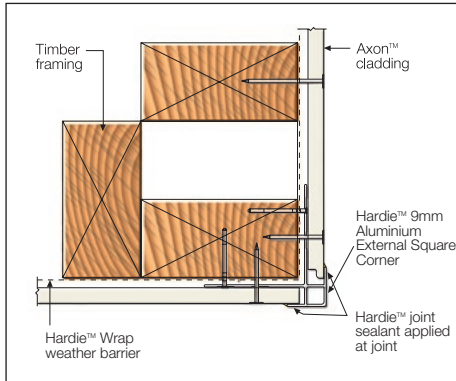

FIGURE 17B ALUMINIUM EXTERNAL SQUARE CORNER

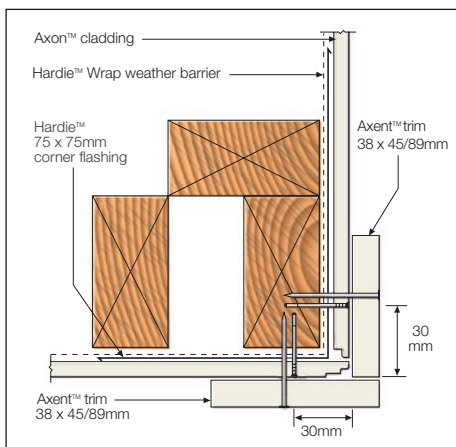

FIGURE 18 TRIM CORNER OPTION

INTERNAL CORNER DETAILS

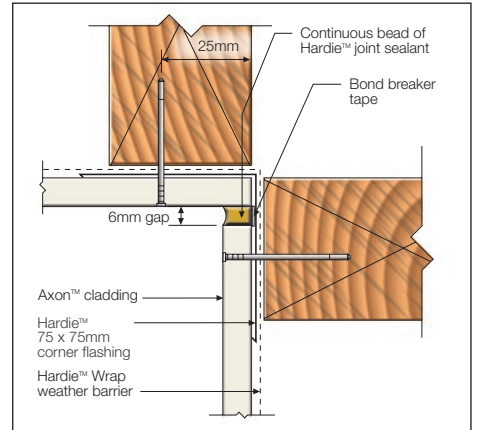

FIGURE 19 SEALANT FILL OPTION

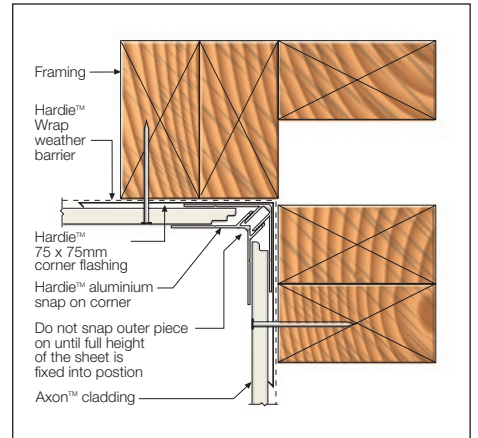

FIGURE 20 SNAP ON CORNER OPTION

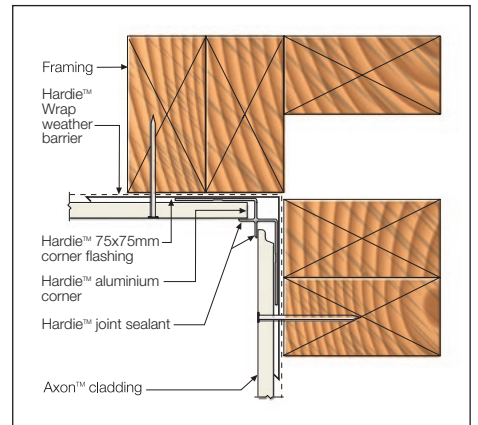

FIGURE 20B ALUMINIUM INTERNAL CORNER

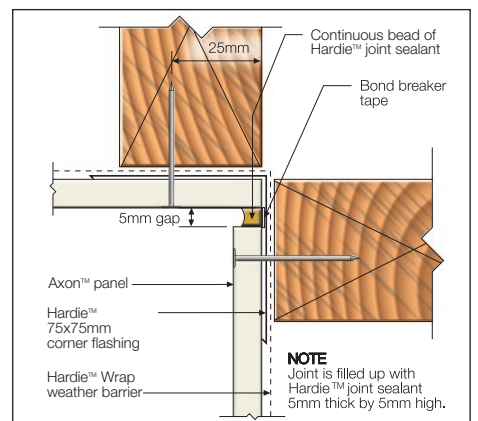

FIGURE 20C SEALANT FILL OPTION

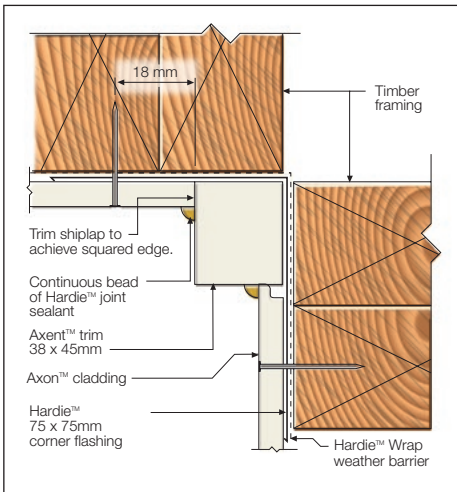

FIGURE 21 TRIM CORNER OPTION

JUNCTION DETAILS

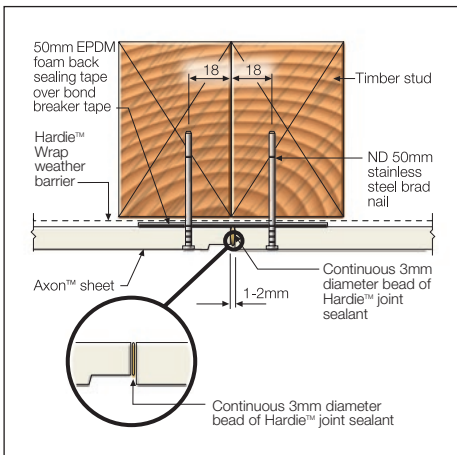

FIGURE 22 VERTICAL BUTT JOINT

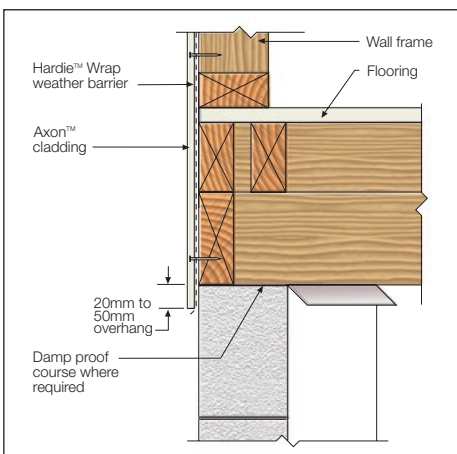

FIGURE 23 LOWER FLOOR JUNCTION

The Axon™ cladding must not continue over a floor junction or where excessive movement or creep will occur, see Figure 24.

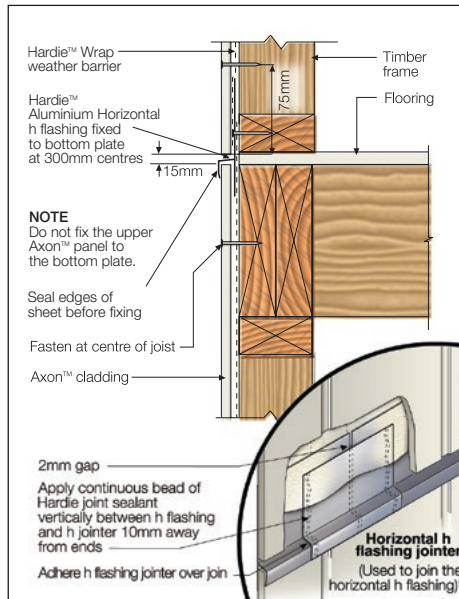

FIGURE 24 UPPER FLOOR JUNCTION/HORIZONTAL JOINT

NOTE: Join the Hardie™ 9mm Aluminium Horizontal h flashing on intermediate studs and not off stud or behind sheet joints.

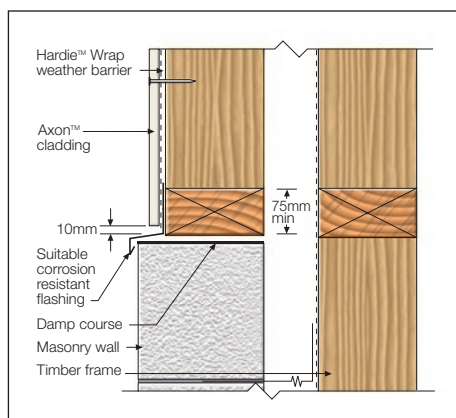

FIGURE 25 HORIZONTAL JUNCTION 1

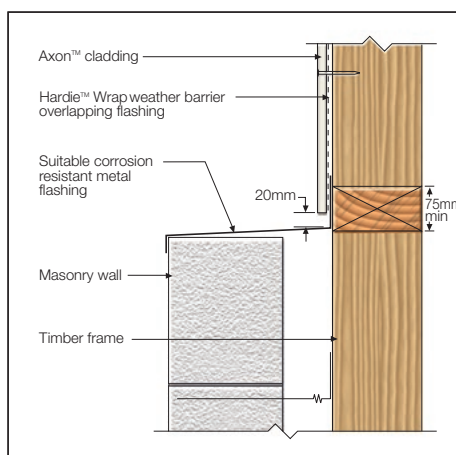

FIGURE 26 HORIZONTAL JUNCTION 2

FINISHING

Sealant

Application and use of sealants must comply with manufacturer's instructions. Sealants, if coated, must be compatible with the paint system. James Hardie recommends the use of Hardie™ joint sealant, which is a paintable polyurethane sealant.

Painting

Axon™ cladding is primed and ready for painting. All sheets must be dry before painting.

Refer to the project specification for paint requirements. Axon™ cladding must be painted within 3 months of being fixed. In areas within 1km of a coastal area or corrosive environment, the Axon™ cladding must be painted immediately after fixing sheets to minimise contamination build up on the heads of the fasteners, as it may lead to fastener corrosion.

James Hardie recommends the application of two coats minimum of a quality acrylic paint over the pre-primed boards in accordance with the paint manufacturer's specifications. If the screw countersunk option is used, it's recommended that any sanded patches are primed before applying the two final coats. Some environments require special coatings including coastal areas. Painting selection and specifications are dependant on the paint chosen. Refer to the paint manufacturer for further information and details of their warranty.

Staining

Some paint manufacturer's such as Cabot's and Watty offer stain systems that they have tested with Hardie™ fibre cement products. For a stained look, contact the James Hardie™ Engineering Solutions team on 13 11 03.

MAINTENANCE

The extent and nature of maintenance will depend on the geographical location and exposure of the building. As a guide, it is recommended that basic normal maintenance tasks shall include but not be limited to:

- Washing down exterior surfaces every 6-12 months*
- Periodic inspections should be made to ensure fasteners are adequately securing the sheets to framing.
- Re-applying of exterior protective finishes*
- Maintaining the exterior envelope and connections including joints, penetrations, flashings and sealants that may provide a means of moisture entry beyond the exterior cladding.
- Cleaning out gutters, blocked pipes and overflows as required.
- Pruning back vegetation that is close to or touching the building.

*Refer to your paint manufacturer for washing down and recoating requirements related to paint performance.

PRODUCT INFORMATION

Material

The basic composition of James Hardie's fibre cement products is Portland cement, ground sand, cellulose fibre, water and proprietary additives.

James Hardie's fibre cement products are manufactured AS/NZS 2908.2 'Cellulose-Cement Products-Flat Sheet'. These are also compliant with equivalent standard ISO 8336 'Fibre-cement flat sheets - Product specification and test methods'. For product classification refer to the relevant Physical Properties Data Sheet.

Durability

Resistance to moisture/rotting

Axon™ cladding has demonstrated resistance to permanent moisture induced deterioration (rotting) by passing the following tests in accordance with AS/NZS 2908.2:

- Water permeability (Clause 8.2.2)
- Warm water (Clause 8.2.4)
- Heat rain (Clause 6.5)
- Soak dry (Clause 8.2.5)

Resistance to termite attack

Based on testing completed by CSIRO Division of Forest Products and Ensis Australia, James Hardie's fibre cement building products have demonstrated resistance to termite attack.

Resistance to fire

The Axon™ cladding is suitable where non-combustible materials are required in accordance with C1.9 of the Building Code of Australia. James Hardie's fibre cement building products have been tested by CSIRO in accordance with AS/NZS 3837 and are classified as conforming to Group 1 material (highest and best result possible), with an average specific extinction area far lower than the permissible 250m²/kg, as referenced in Specification C1.10a of the National Construction Code (NCC)."

Alpine regions

In regions subject to freeze/thaw conditions, all fibre cement external cladding must be installed and painted in the warmer months of the year where the temperature does not create freeze and thaw conditions or paint issues. The cladding must be painted immediately after installation. In addition, fibre cement cladding must not be in direct contact with snow and/or ice build up for extended periods, e.g. external walls in alpine regions subject to snow drifts over winter.

Furthermore, a reputable paint manufacturer must be consulted in regards to a suitable product, specifications and warranty. The paint application must not be carried out if the air temperature or the substrate temperature is outside the paint manufacturer's recommendation including the specified drying temperature range.

Hardie™ external cladding products are tested for resistance to frost in accordance with AS/NZS 2908.2 Clause 8.2.3.

Ask James Hardie™
Call 13 11 03
www.jameshardie.com.au

Notes

Notes



**For information and advice
call 13 11 03 | jameshardie.com.au**

Australia September 2021

© 2021 James Hardie Australia Pty Ltd ABN 12 084 635 558
™ and © denote a trademark or registered mark owned by James Hardie Technology Limited.